

SOKKIA

B20/B30/B40

Automatic Level

OPERATOR'S MANUAL

Thank you for selecting the B20/B30/B40.

- Please read this operator's manual carefully before using this product.
- Verify that all equipment is included.



"8. STANDARD EQUIPMENT"

- The specifications and general appearance of the instrument are subject to change without prior notice and without obligation by Sokkia Topcon Co., Ltd. and may differ from those appearing in this manual.
- The content of this manual is subject to change without notice.
- Illustrations appearing in this manual are of B20.
- Some of the diagrams shown in this manual may be simplified for easier understanding.

CONTENTS

1. PRECAUTIONS FOR SAFE OPERATION	1
2. PRECAUTIONS	5
3. FEATURES OF B20/B30/B40	7
4. PARTS OF THE INSTRUMENT	8
5. PRELIMINARIES	9
5.1 SETTING UP THE INSTRUMENT	9
5.2 FOCUSING AND SIGHTING	11
6. OPERATION	13
6.1 MEASURING HEIGHT DIFFERENCE	13
6.2 MEASURING HORIZONTAL ANGLE	15
6.3 MEASURING DISTANCE USING THE STADIA LINES	16
7. CHECKS AND ADJUSTMENTS	17
7.1 CIRCULAR LEVEL	17
7.2 AUTOMATIC COMPENSATOR	18
7.3 RETICLE CROSS-LINE (LINE OF SIGHT)	19
8. STANDARD EQUIPMENT	21
9. OPTIONAL ACCESSORIES	23
10. SPECIFICATIONS	27

1. PRECAUTIONS FOR SAFE OPERATION

For the safe use of the product and prevention of injury to operators and other persons as well as prevention of property damage, items which should be observed are indicated by an exclamation point within a triangle used with WARNING and CAUTION statements in this operator's manual.

The definitions of the indications are listed below. Be sure you understand them before reading the manual's main text.

Definition of Indication



WARNING

Ignoring this indication and making an operation error could possibly result in death or serious injury to the operator.



CAUTION

Ignoring this indication and making an operation error could possibly result in minor injury or property damage.



This symbol indicates items for which caution (hazard warnings inclusive) is urged. Specific details are printed in or near the symbol.



This symbol indicates items which are prohibited. Specific details are printed in or near the symbol.



This symbol indicates items which must always be performed. Specific details are printed in or near the symbol.

GENERAL



WARNING



Never look at the sun through the telescope. Loss of eyesight could result.



Do not look at reflected sunlight from a prism or other reflecting object through the telescope. Loss of eyesight could result.



When securing the instrument in the carrying case make sure that all catches, including the side catches, are closed. Failure to do so could result in the instrument falling out while being carried, causing injury.



CAUTION



Do not use the carrying case as a footstool. The case is slippery and unstable so a person could slip and fall off it.



Do not place the instrument in a case with a damaged catch or belt. The case or instrument could be dropped and cause injury.



Do not wield or throw the plumb bob. A person could be injured if struck.

TRIPOD



CAUTION



When mounting the instrument to the tripod, tighten the centring screw securely. Failure to tighten the screw properly could result in the instrument falling off the tripod causing injury.



Tighten securely the leg fixing screws of the tripod on which the instrument is mounted. Failure to tighten the screws could result in the tripod collapsing, causing injury.



Do not carry the tripod with the tripod shoes pointed at other persons. A person could be injured if struck by the tripod shoes.



Keep hands and feet away from the tripod shoes when fixing the tripod in the ground. A hand or foot stab wound could result.



Tighten the leg fixing screws securely before carrying the tripod. Failure to tighten the screws could lead to the tripod legs extending, causing injury.

STAFF



WARNING



Do not use under thunderous weather conditions. Staff is conductive and if struck by lightning, death or injury could result.



Handle with care when using near high voltage cables or transformers. Staff is conductive and contact could result in electric shock.

2. PRECAUTIONS

GENERAL

- The B20/B30/B40 is a precision instrument. Handle with care and avoid heavy shocks and vibration.
- Never place the instrument directly on the ground.
- When the instrument is left on the tripod, cap the objective lens and cover the entire instrument with the vinyl cover provided.
- When the instrument is placed in the case, store the accessories in their specified places.

MAINTENANCE

- Wipe off moisture completely if the instrument gets wet during survey work.
- Always clean the instrument before returning it to the case. The lens requires special care. Dust it off with a clean cloth first to remove tiny particles. Then, after providing a little condensation by breathing on the lens, wipe it with a soft clean cloth or lens tissue.
- To clean the instrument or carrying case, lightly moisten a soft cloth in a mild detergent solution. Wring out excess water until the cloth is slightly damp, then carefully wipe the surface of the unit. Do not use any organic solvents or alkaline cleaning solutions.
- Check the tripod for loose fit and loose screws.
- If any trouble is found on the rotatable portion, screws or optical parts (e.g. lens), contact your local dealer.
- Check the instrument for proper adjustment periodically to maintain the instrument accuracy.

EXCEPTIONS FROM RESPONSIBILITY

- The user of this product is expected to follow all operating instructions and make periodic checks (hardware only) of the product's performance.
- The manufacturer, or its representatives, assumes no responsibility for results of a faulty or intentional usage or misuse including any direct, indirect, consequential damage, and loss of profits.
- The manufacturer, or its representatives, assumes no responsibility for consequential damage, and loss of profits due to any natural disaster, (earthquake, storms, floods etc.), fire, accident, or an act of a third party and/or a usage under unusual conditions.
- The manufacturer, or its representatives, assumes no responsibility for any damage, and loss of profits due to a change of data, loss of data, an interruption of business etc., caused by using the product or an unusable product.
- The manufacturer, or its representatives, assumes no responsibility for any damage, and loss of profits caused by usage different to that explained in the operator's manual.
- The manufacturer, or its representatives, assumes no responsibility for damage caused by incorrect operation, or action resulting from connection to other products.

3. FEATURES OF B20/B30/B40

The B20/B30/B40 is equipped with a fast-action, magnetically-damped, automatic compensator. After the instrument has been approximately leveled using the circular level, the line of sight is accurately leveled by the automatic compensating mechanism.

The B20/B30/B40 has been designed to allow stable surveying operations regardless of environmental conditions such as vibration and temperature changes.

The B20/B30/B40 has a simple horizontal circle for angle measurement, and the stadia lines on the reticle can be used for approximate distance measurement.

The B20/B30/B40 is ideally suited for general survey work, civil engineering and construction work.



- The instrument is accurately leveled when the bubble is within the center circle of the circular level.

4. PARTS OF THE INSTRUMENT

(Instrument shown: B20)

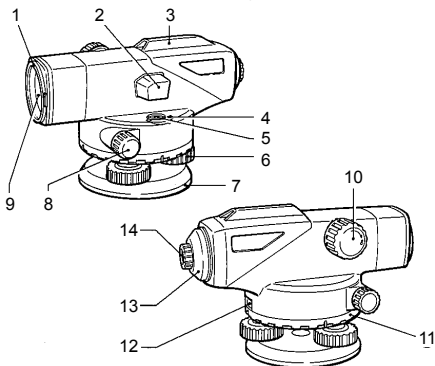

1. Lens hood (B20 only)
2. Prism (B20)/Reflector (B30/40)
3. Peep sight^{*1}
4. Circular level adjusting screw
5. Circular level
6. Leveling foot screw
7. Base plate
8. Horizontal fine motion screw
9. Objective lens
10. Focussing knob
11. Horizontal circle positioning ring
12. Horizontal circle window
13. Reticle adjusting screw cover
14. Eyepiece^{*2}

^{*1} The B40 has a gun sight.

^{*2} The B20 eyepiece is detachable.

5. PRELIMINARIES

5.1 SETTING UP THE INSTRUMENT

- 1** Unbuckle the band around the tripod legs and loosen the extension clamp screws.

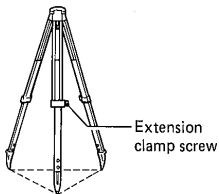

- 2** With the tripod closed, extend the tripod legs until the tripod head is roughly at eye level, then re-tighten the clamp screws.
- 3** Spread the tripod legs so that the leg tips form a regular triangle on the ground.
- 4** Make sure that the tripod head is approximately level. Fix the tripod shoes firmly into the ground.

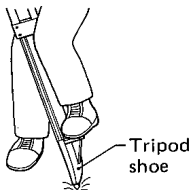

- 5** Hold the instrument on the tripod head and tighten the centering screw.

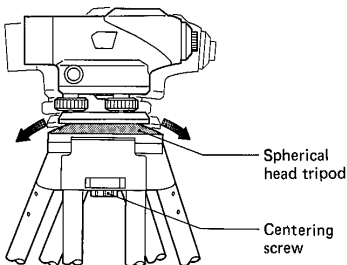

- 6** When using the spherical head tripod, slightly loosen the centering screw, hold the base plate in both hands, and slide it across the tripod head until the bubble is in the proximity of the circular level.

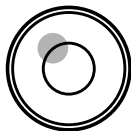

- 7** Tighten the centering screw.

- 8** Adjust the leveling foot screws until the bubble is exactly centered in the center circle.

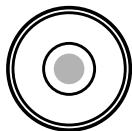

5.2 FOCUSING AND SIGHTING

- 1 Use the peep sight or gun sight to point the objective lens at the target.
- 2 Gradually turn the eyepiece until just before the reticle cross-line becomes blurred.

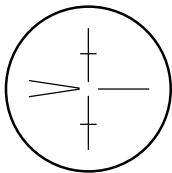

- 3 Use the horizontal fine motion screw to center the target in the field of view. Turn the focussing knob to focus on the target.

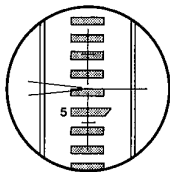

Note

- Focussing is coarse while the B20 focussing knob feels heavy to rotate. Rotating in the reverse direction (less heavy) will give a fine focussing motion.
- 4 Looking through the telescope, shift your eyes slightly in the horizontal and vertical directions.

- 5** If there is no parallax between the target image and the reticle, preparations for measurement are complete. If there is parallax, repeat the above procedure from step 2 in order to refocus the reticle.

 Note

- If there is parallax, measurement errors may result, so make sure to adequately focus the target.
- Use the lens hood (B20 only) in strong light conditions.

6. OPERATION

6.1 MEASURING HEIGHT DIFFERENCE

- 1 Set up the instrument at a point approximately halfway between points A and B. The reticle stadia lines can be used to optically compare the distances. (See "6.3 MEASURING DISTANCE USING THE STADIA LINES".)



- For more accurate measurement, set the instrument as close to halfway as possible, to eliminate errors due to sighting axis misalignment.

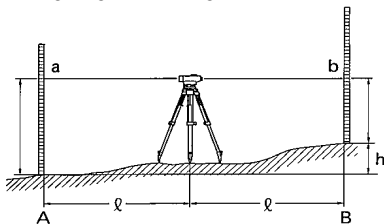

- 2 Position the staff vertically at point A. Take the reading a (backsight) on the staff at point A.
- 3 Then sight the staff at point B and obtain the reading b (foresight).
- 4 The difference $a - b$ is the height difference h of B from A.

Example:

$$h = a - b = 1.735\text{m} - 1.224\text{m} = 0.511\text{m}$$

Therefore point B is 0.511m higher than point A.
(The value of h will be negative if point B is lower than point A.)

<When the distance between points A and B is large or if the height difference is great>

- 1 Divide the distance into a number of sections and determine the height difference of each section.

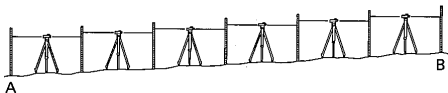

- 2 The height difference between points A and B is the total of the height differences of all the sections.

The general formula is:

Altitude of the required point = altitude of known point + total of backsight values - total of foresight values.

Note

- This simple leveling technique has no error check. It is better to measure from A to B and back to A so that the error of closure can be calculated.

6.2 MEASURING HORIZONTAL ANGLE

The horizontal circle graduations are annotated every 10° (360°) or 10 gon (400 gon) in a clockwise direction. As a result, sighting is performed from left to right.

- 1 Use the plumb bob to set up the instrument directly above the survey point.

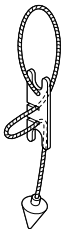

- 2 Sight point A, and set the horizontal circle to 0° by turning the horizontal circle positioning ring.

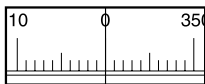

- 3 Sight point B and take the angle reading.
Example: 91.5° (or 91.5 gon) in the figure below.

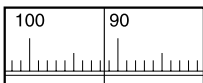

6.3 MEASURING DISTANCE USING THE STADIA LINES

The stadia lines etched on the reticle can be used for distance measurements.

- 1 Sight the staff, and count the number of centimeters, ℓ , between the two stadia lines.

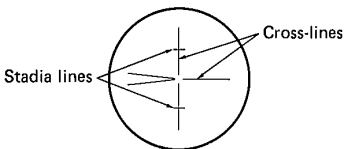

- 2 This number is equivalent to the distance in meters between the staff and the instrument.

Example:

If the length (ℓ) is 32 cm, the horizontal distance from the instrument center A to the staff B is 32 m.

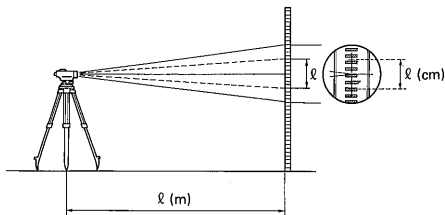

7. CHECKS AND ADJUSTMENTS

7.1 CIRCULAR LEVEL

- 1 Adjust the leveling foot screws to center the bubble in the circular level.
- 2 Turn the instrument 180° (or 200 gon).

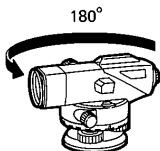

If the bubble is inside the circle, no adjustment is necessary. If the bubble shifts from within the circle, adjust as follows:

- 3 Compensate for one-half of the shift by adjusting the leveling foot screws.
- 4 Eliminate the remaining half shift with the circular level adjusting screws using the hexagonal wrench.
- 5 Turn the instrument 180° (or 200 gon). If the bubble remains in the circle, adjustment is complete.

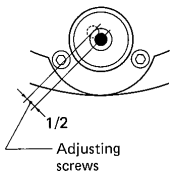
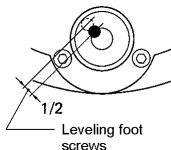

7.2 AUTOMATIC COMPENSATOR

- 1** Center the bubble in the circular level.
- 2** While turning the nearest leveling screw to the sighting axis $1/8$ of a turn to the right or left, check the movement of the horizontal cross-line. (Another method is to tap the tripod legs or the main body while sighting a clear target.)

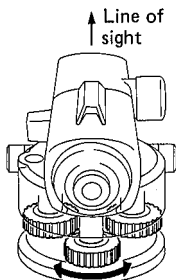

If the automatic compensator mechanism is working normally the cross-line should bounce, then immediately return to the original position. It is advisable to check the movement of the automatic compensator before use.

7.3 RETICLE CROSS-LINE (LINE OF SIGHT)

- 1 Set the instrument halfway between two points, A and B, 30 to 50m apart. Take readings a_1 and b_1 .

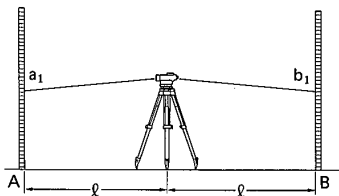

- 2 Set the instrument at a point 2 m from point A. Take readings a_2 and b_2 .

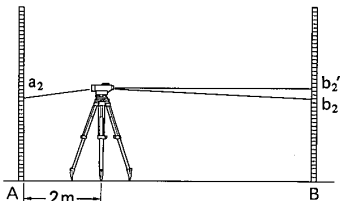

Leave the telescope sighted on point B.

Calculate

$$b_2' = a_2 - (a_1 - b_1)$$

If $b_2' = b_2$, the horizontal cross-line is normal and no adjustment is necessary.

When b_2' and b_2 are different, adjust the cross-line as follows:

- 3** Unscrew and remove the adjusting screw cover.

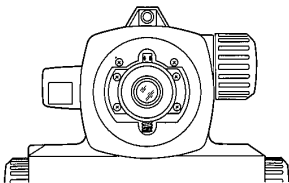

- 4** Use the adjusting pin to eliminate the difference between b_2' and b_2 . (See "8. STANDARD EQUIPMENT".) In the example shown in step **2** b_2' is larger than b_2 . The horizontal line needs to be lowered. To lower the horizontal line, carefully loosen the adjusting screw by a small amount using the adjusting pin. To raise the horizontal line, tighten the adjusting screw.

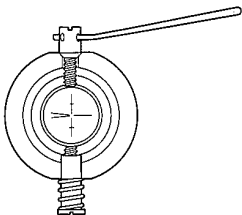

- 5** Repeat steps **1** and **2** of the adjustment procedure until the difference between b_2' and b_2 is small.

8. STANDARD EQUIPMENT

B20

(Packing layout)

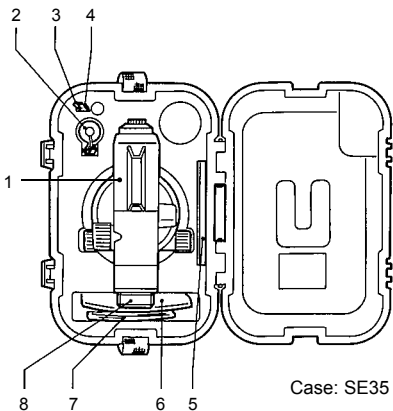

1. Main unit	1
2. Plumb bob	1
3. Hexagonal wrench	1
4. Adjusting pin	2
5. Operator's manual	1
6. Vinyl cover	1
7. Cleaning cloth	1
8. Lens cap	1

B30/40

(Packing layout)

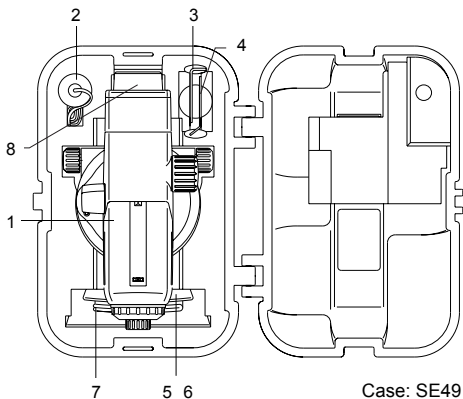

Case: SE49

1. Main unit	1
2. Plumb bob	1
3. Hexagonal wrench	1
4. Adjusting pin	2
5. Operator's manual	1
6. Vinyl cover	1
7. Cleaning cloth	1
8. Lens cap	1

9. OPTIONAL ACCESSORIES

• ILLUMINATION PACK LA8 (B20 only)

The illumination pack, LA8, is available for use when leveling in low light conditions.

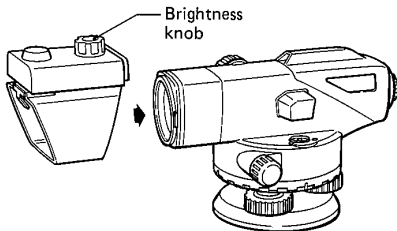

- 1** Slide it onto the telescope as far as it will go. (The lens hood should be retracted.)
- 2** Switch the unit on and adjust the brightness using the knob.

• OPTICAL MICROMETER OM5 (B20 only)

The detachable optical micrometer OM5 is available for high precision leveling. Turning the micrometer knob shifts the line of sight of the telescope vertically a maximum of 10 mm. This micrometer shift can be displayed in 0.1 mm graduations. (Minimum sighting distance: 1 m)

Use first order staves with 1 cm graduations or similar precision staves.

9. OPTIONAL ACCESSORIES

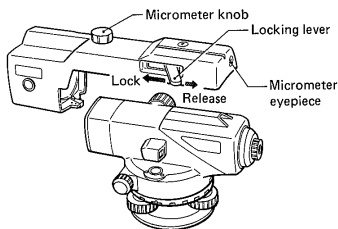

- 1** Mount the OM5 on the telescope of the B20 and push the locking lever fully forward to lock it. (The lens hood should be retracted.)
- 2** Turn the micrometer knob to move the line of sight until the graduation mark on the staff comes to the middle point between the two wedge reticle lines for an accurate reading.
- 3** Take the micrometer reading in the micrometer eyepiece. One division corresponds to 0.1 mm.
- 4** Adding the micrometer reading to the staff graduations reading gives the measurement value.

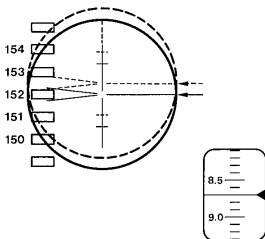

Example:

Staff graduation	152	cm
Micrometer	+	8.7 mm
		<hr/>
		152.87 cm



- For accurate measurement, the last adjustment of the micrometer knob should be in the clockwise direction.

• DIAGONAL EYEPIECE DE16/DE22

The diagonal eyepiece DE16/DE22 is available for use in restricted viewing positions.

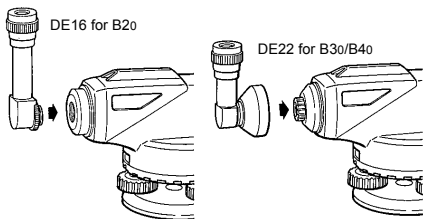

- 1** To attach the DE16, remove the eyepiece by unscrewing to the left, and screw in the diagonal eyepiece.
To attach the DE22, push it on to the reticle adjusting screw cover.
- 2** Holding the base of the DE16/DE22, focus on the reticle by turning the eyepiece of the DE16/DE22.
Perform focussing and sighting as described in "5.2 FOCUSING AND SIGHTING"



- The B20 detachable eyepiece can also be replaced by the optional 40x eyepiece (EL5).
- **REMOVABLE EYEPIECE EL5** (B20 only)

Increases the standard 32X image to 40X.

10. SPECIFICATIONS

	B20	B30	B40
Telescope			
Length	215mm (8.46 in.)		
Image	Erect		
Objective aperture	42mm (1.65 in.)	36mm (1.42 in.)	32mm (1.26 in.)
Magnification	32X	28X	24X
Field of view (at 100m/328ft.)	1°20' (2.3m/7.5ft.)	1°25' (2.5m/8.2ft.)	
Resolving power	3.0"	3.5"	4.0"
Minimum focus	0.3m (1ft.)		
Stadia ratio	1:100		
Additive constant	0		
Horizontal circle			
Diameter	103mm (4.1in.)		
Graduation	1° / 1gon		
Automatic compensator			
Range	±15'		
Circular level			
Sensitivity	10' / 2mm		
Standard deviation for 1 km of double run leveling			
	0.7mm (0.03in.)	1.5mm (0.06in.)	2.0mm (0.08in.)
With micrometer	0.5mm (0.02in.)	_____	
Water resistance	IPx6 (IEC60529:2001)		
Operating temperature range	-20 to 50°C (-4 to 122°F)		
Storage temperature range	-40 to 70°C (-40 to 158°F)		

Size	Width	130mm (5.12in.)	
	Length	215mm (8.46in.)	
	Height	140mm (5.51in.)	135mm (5.31in.)
Weight		1.85kg (4.1 lbs)	1.7kg (3.7 lbs)

お問い合わせ先

株式会社 ソキア販売

東京都板橋区小豆沢1-5-2 〒174-0051
TEL 03-5915-6560 FAX 03-5915-6658

株式会社 **ソキア・トプコン**

<http://www.sokkia.co.jp>

神奈川県厚木市長谷 260-63 〒243-0036

SOKKIA TOPCON CO., LTD.

<http://www.sokkia.co.jp/english/>

260-63 HASE, ATSUGI, KANAGAWA, 243-0036 JAPAN

第 1 版 01-1003/1st ed. 01-1003

©2010 SOKKIA TOPCON CO., LTD.